













Cruzber S.A., ES-A14018311
P.I. Las Salinas II, E-14960 Rute
www.cruzber.com



- (E)** **Instrucción de montaje**
¡Leer primero!
- (GB)** **Assembly instructions**
Read first!
- (F)** **Instruction de montage**
Lire en premier!
- (D)** **Montageanleitung**
Zuerst lesen!
- (PT)** **Instruções de montagem**
Ler primeiro!
- (PL)** **Instrukcja montażu**
Najpierw przeczytaj!
- (CZ)** **Montážní návod**
Čtěte pozorně!
- (HU)** **Szerelési Utasítás**
Először olvassd el!
- (RO)** **Instructiuni de montaj**
Intai cititi!
- (HR)** **Detaljne upute**
Prvo pročitati!
- (GR)** **Διαβάστε προσεκτικά τις**
Οδηγίες Συναρμολόγησης!
- (TR)** **Öncelikle montaj:**
Talimatlarını okuyunuz!
- (RU)** **Инструкции по монтажу**
Сначала прочитайте!
- (IT)** **Istruzioni di montaggio**
Leggere per primo!
- (NL)** **Montagehandleiding**
Eerst lezen!
- (SLO)** **Navodila za sestavljanje**
Preberite!





- Kit fijación pasarela
- Walkway fixation kit
- Kit fixation passage
- Laufsteg Befestigungs-Kit
- Kit fixação passareira
- Element mocujący - podest do chodzenia po platformie
- Fixační kit obslužná lávka
- Palló szállanyag szállításra készlet
- Kit de fixare pasarelă
- Kit za montažu šetnja
- Κιβώτιο Επισκευής δίοδος
- Montaj kiti yürüme yolu
- Крепежный комплект Мостки
- Kit di fissaggio della passerella
- Loopplankbevestigingsset
- Pešpot posnetek komplet

Código Code Code Kode	941-270/1/2
	Lv 7 2016 - r5
Modelo Model Modèle Modell	Serie-N+ Serie-N
Lote Lot Lot Lot	   
	Peso Weight Poids Gewicht

- (E)** **Contenido embalaje:** ¡Verificar!
- (GB)** **Package content:** Check!
- (F)** **Contenu d'emballage:** Vérifier!
- (D)** **Packungsinhalt:** Überprüfen!
- (PT)** **Contéudo embalagem:** Verificar!
- (PL)** **Zawartość opakowania:** sprawdź!
- (CZ)** **Obsah balení:** Zkontrolujte!
- (HU)** **Csomag tartalma:** Ellenőrizd!
- (RO)** **Pachetul contine:** Verificati!
- (HR)** **Sadržaj paketa:** Provjeri!
- (GR)** **Ελέγξτε το περιεχόμενο:** του πακέτου!
- (TR)** **Paket içeriğini:** Control ediniz!
- (RU)** **Содержание упаковки:** Проверьте!
- (IT)** **Contenuto della confezione:** Controllare!
- (NL)** **Pakket inhoud:** Controleer!
- (SLO)** **Vsebina paketa:** Preverite!

	1°		
	2°		
			

x 1	x 1		
			

Código Code						Lote Lot
941-270	Serie N+ Serie-N	2x (821-079)	2x (821-076)	1x (805-111)	0,35 kg	01/10
941-271		2x (821-079)	4x (821-076)	1x (805-111) 1x (810-066)	0,49 kg	01/10
941-272		2x (821-079)	6x (821-076)	1x (805-111) 1x (810-044)	0,62 kg	01/10

Código
Code
Code
Kode

941-270/1/2

Lv 7 2016 - r 5



Importante!
Important!
Important!
Wichtig!

- E** Este accesorio tiene que usarse con sistemas portacargas Cruz!
- GB** This accessory must be used with Cruz roof rack systems!
- F** Cet accessoire devra être utilisé avec des systèmes porte-charge-ment Cruz!
- D** Dieses Zubehör muß mit einem Cruz Trägersystem verwendet werden!
- PT** Este accesorio deve ser utilizado com sistemas porta cargas Cruz!
- PL** To wyposażenie musi być używane z systemami bagażnika dachowego firmy Cruz!
- CZ** Toto příslušenství musí být používáno s nosným systémem Cruz!
- HU** Ez a kiegészítő Cruz rudakkal használható a csomagtartó rendszerekhez!
- RO** Această accesoriu trebuie utilizat, cu sisteme Cruz!
- HR** Ovi dodaci moraju biti korišteni uz Cruz sistem krovnog nosača!
- GR** Το αξεσουάρ αυτό θα πρέπει να χρησιμοποιείται αποκλειστικά στα συστήματα μπαρών της Cruz!
- TR** Bu aksesuarlar mutlak Cruz taşıma sistemleriyle kullanılmalıdır!
- RU** Данный аксессуар должен быть использован с багажной системой на крышу марки Cruz!
- IT** Questo accessorio deve essere utilizzato con i sistemi a barre Cruz!
- NL** Dit accessoire moet worden gebruikt in combinatie met een Cruz dakdragersysteem!
- SLO** Dodatek naj se uporablja le z izdelki iz asortimana strešnih košar CRUZ!

1

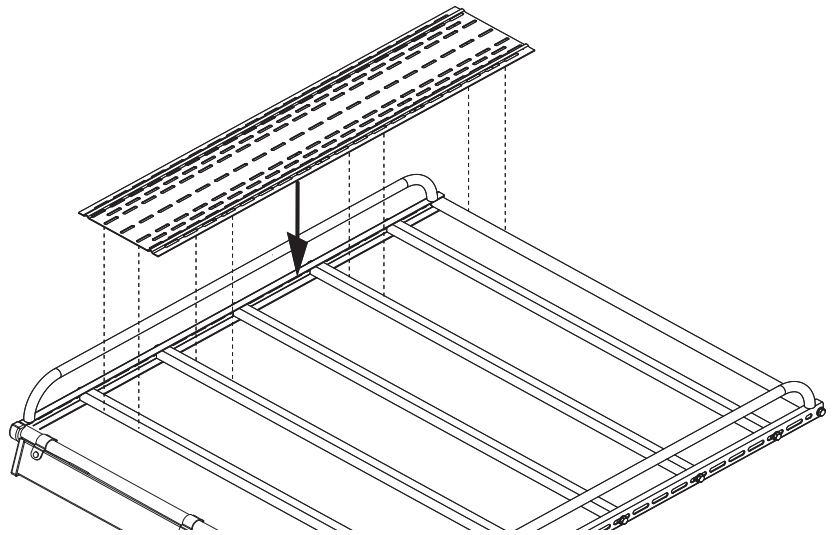

2



941-271
941-272

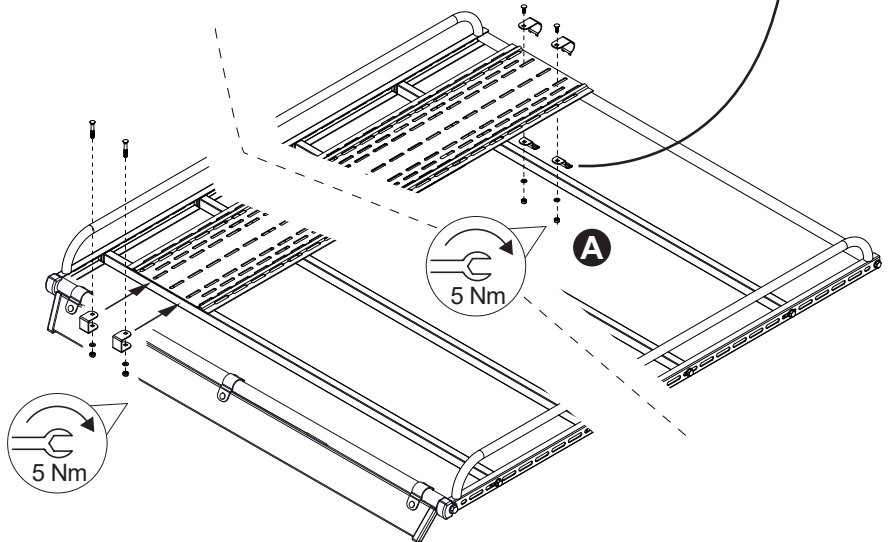
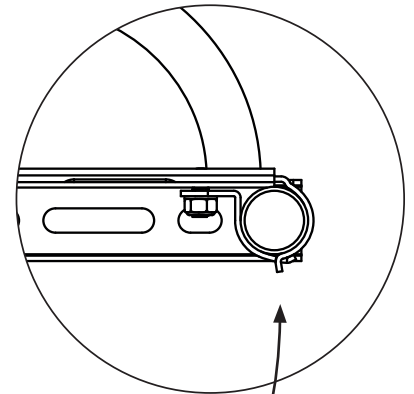
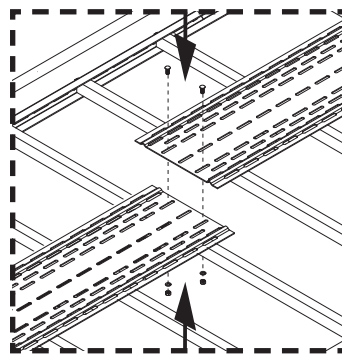

3

